

2 1 3

A



PUMP ROTATION:
Clockwise: Firing Order: 1-5-3-6-2-4
DRIVE END:
R. H. Side
TIMED FOR PORT CLOSING
SPECIAL FEATURES:
10mm Cam Lift

MACK
MODEL 300 #PLM 450213

Special Information:

SERVICE PARTS

Following are all parts, part numbers, pump codes and calibrations for the Model: #PLM 450213 The exploded view drawing below is detailed with part numbers

listed on the pages indicated. Refer to the Index Section for explanations of codes and abbreviations.

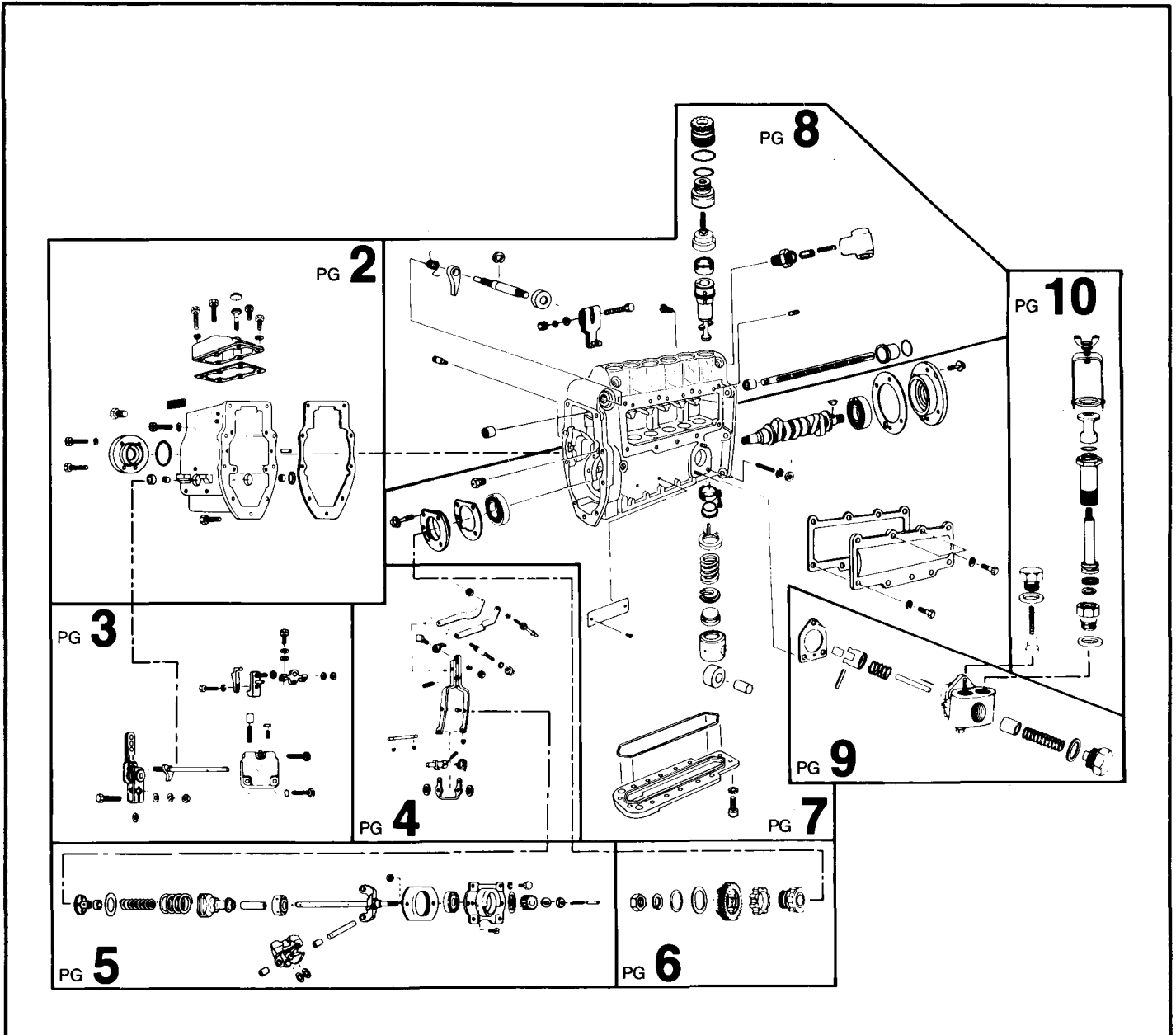

MODEL 300 #PLM 450213

ASSY GMS 450214
GOVERNOR ASSY

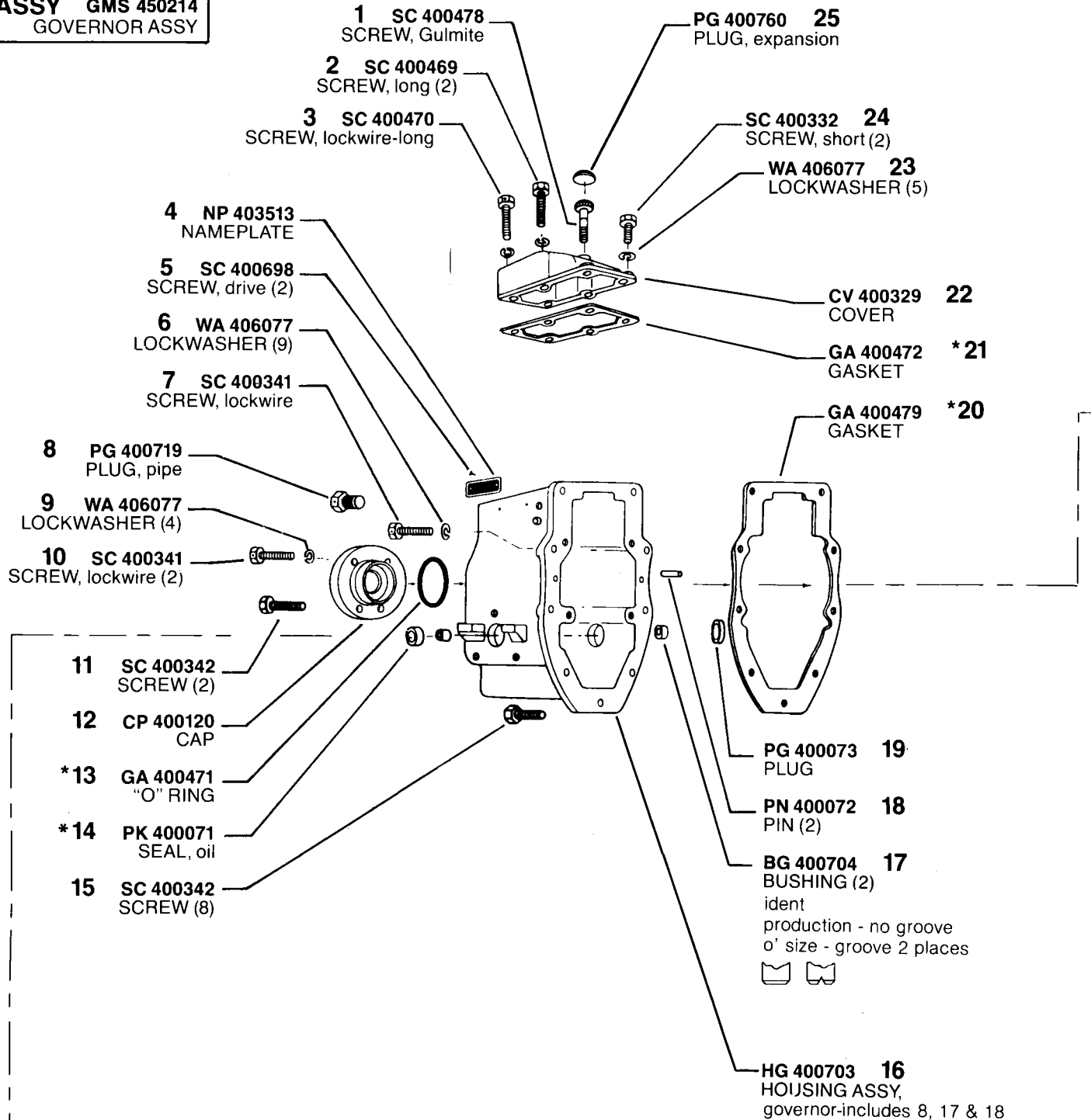

*Quantity used is one, unless otherwise indicated in parenthesis () following description of part.

*Denotes parts in Gasket Kit KT 401705

MODEL 300 #PLM 450213

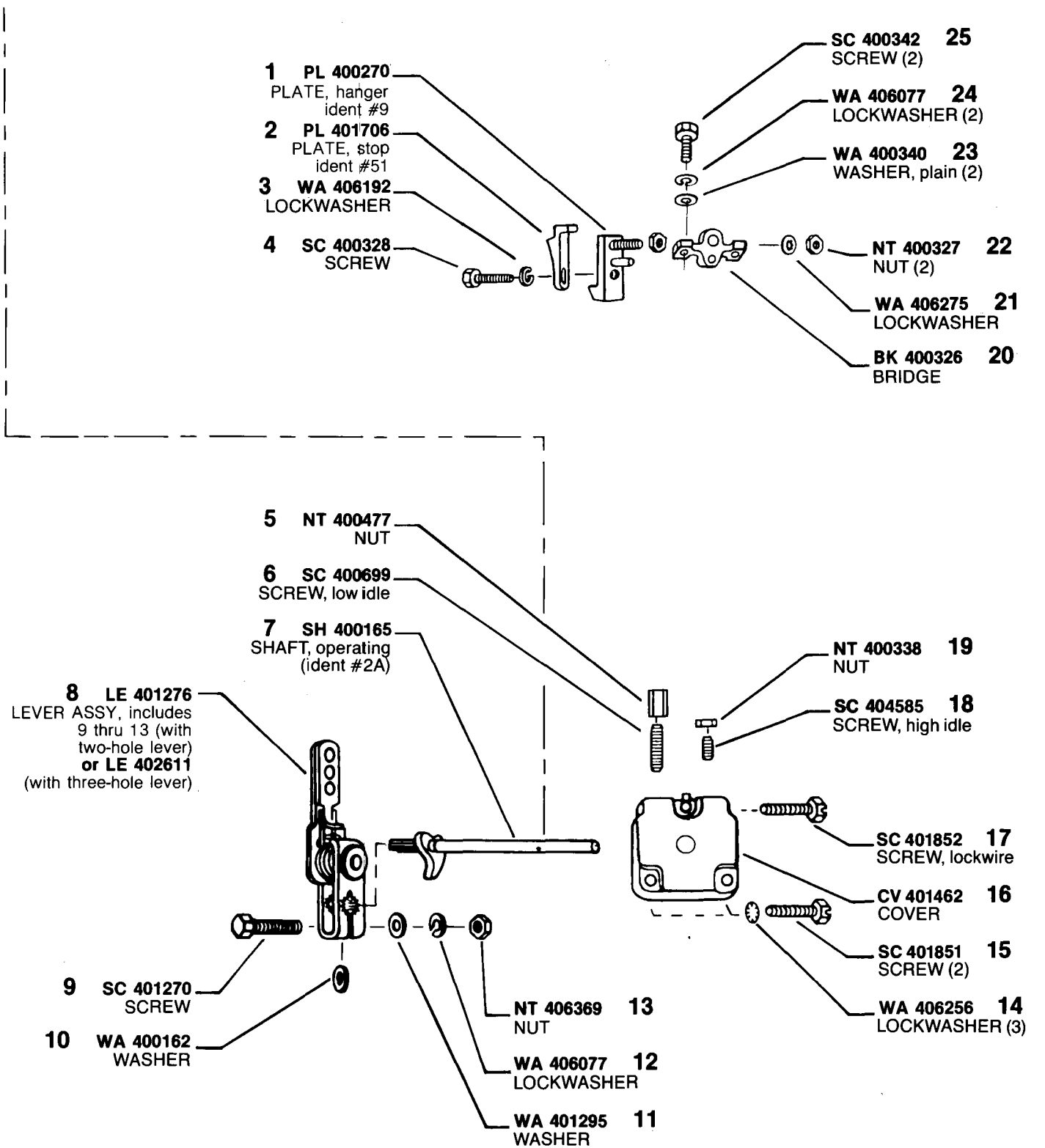

MODEL 300 #PLM 450213

ASSY LE 400782
LEVER ASSY, fulcrum-
includes 1, 2, 6 thru 9
11 & 16 thru 21

ASSY PL 400177
PLATE ASSY, includes
10 & 12

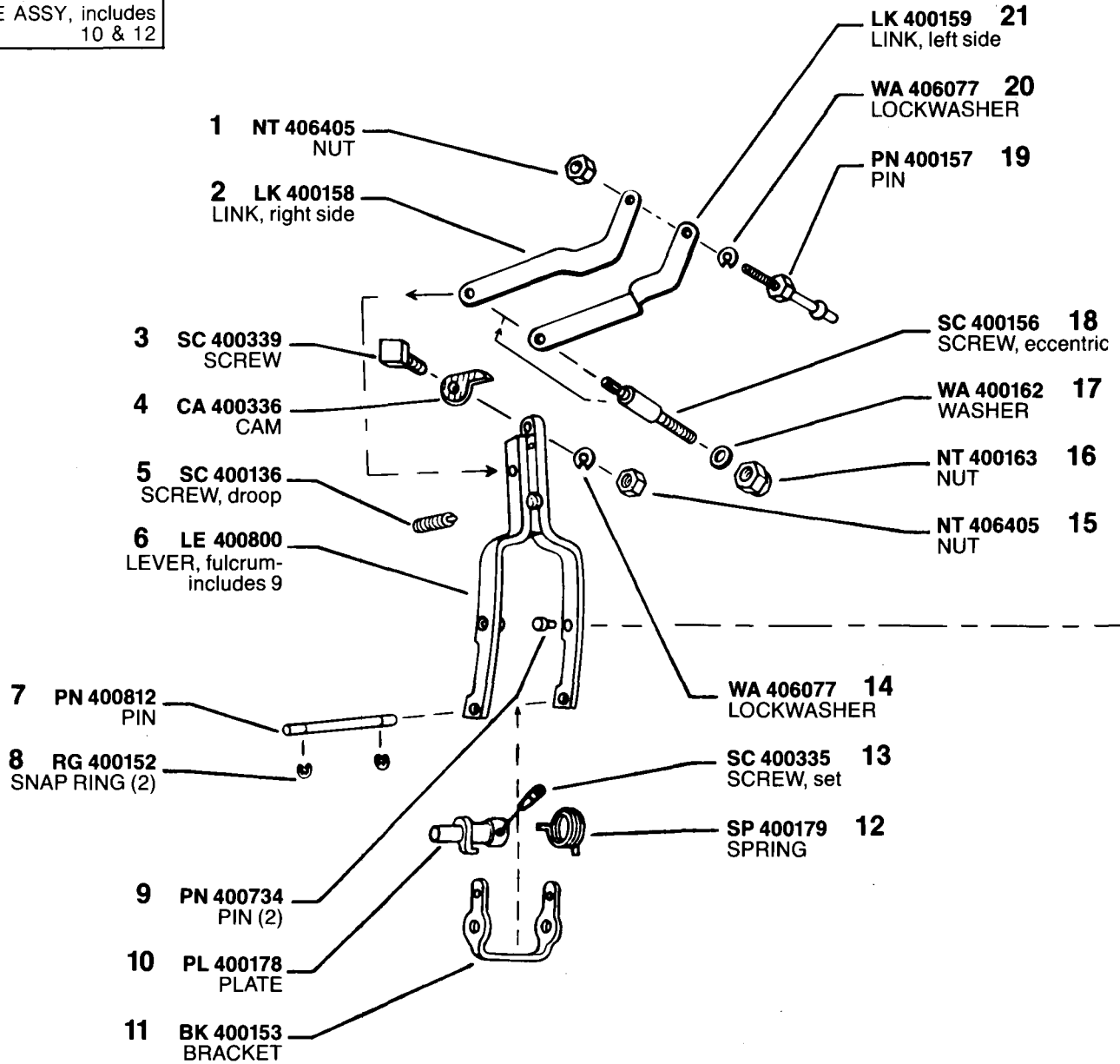

MODEL 300 #PLM 450213

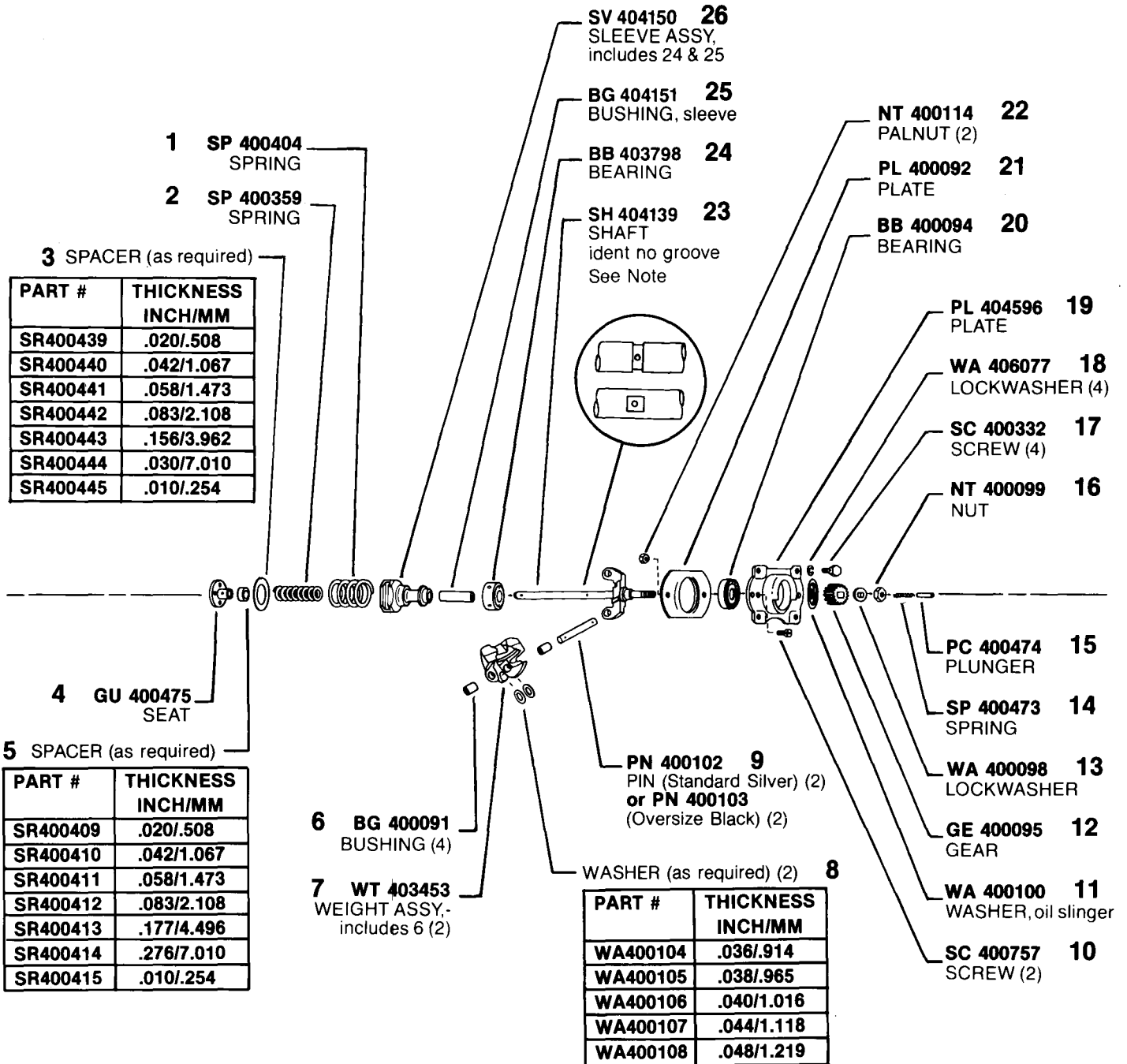

NOTE: When replacing shaft (#23 w/groove) with latest shaft (SH404139 no groove) BG404151 (25) MUST be used. Shaft with groove used BG400118.

MODEL 300 #PLM 450213

**ASSY GE 400182
or 408663
(RUBBER DRIVE)**
DRIVE ASSY, includes 3 thru 7

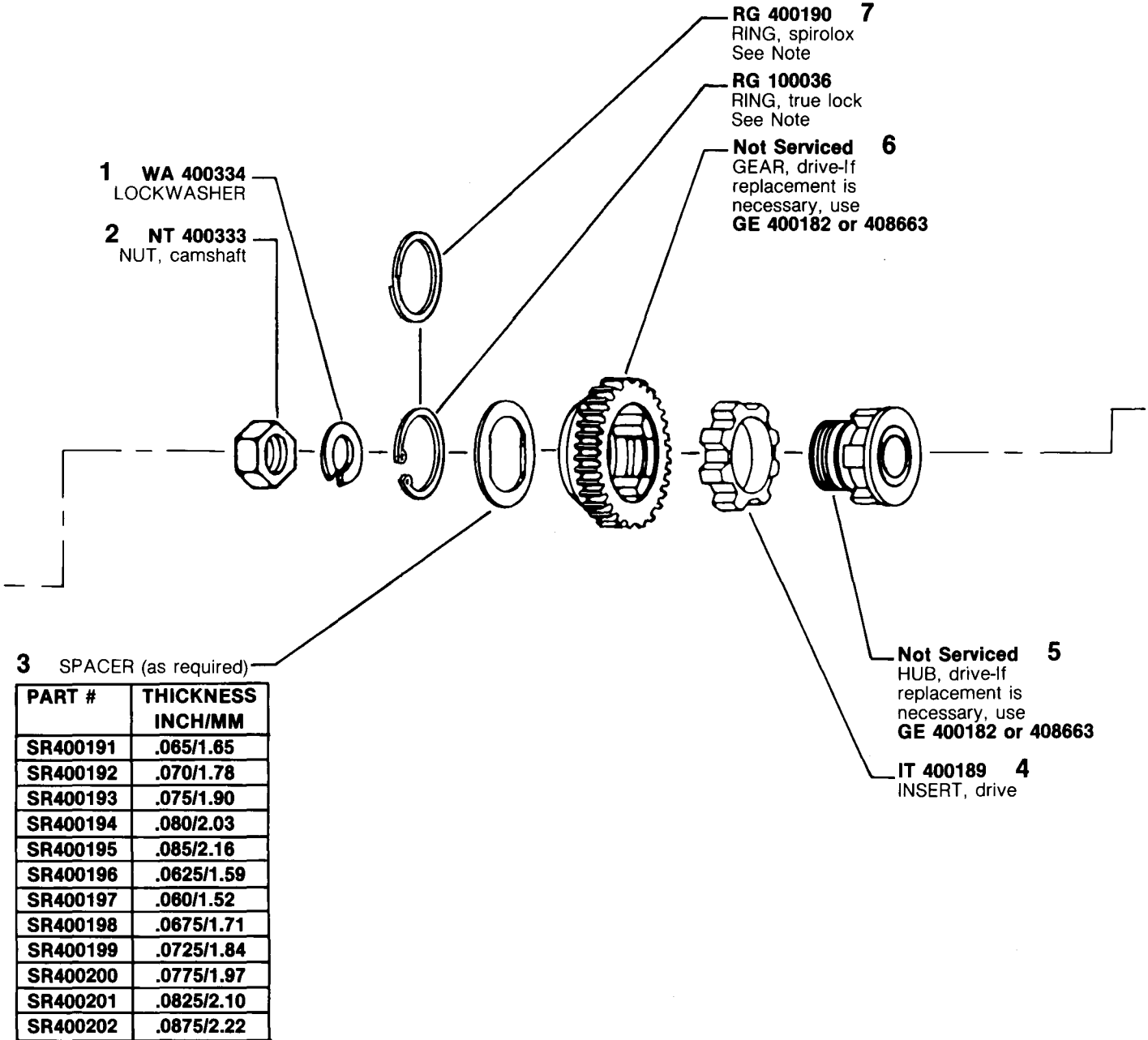

#7 NOTE: Earlier rubber drive assy GE 400182 used RG 400190 (Spirolox ring), later assy GE 408663 using RG 100036 (true lock ring). Spirolox & true lock rings are NOT interchangeable.
ASSY NOTE: Pumps equipped with GE 7992A "Friction Clutch" refer to Service Instructions Model 688T Parts Bulletin P4 for Parts.

MODEL 300 #PLM 450213

ASSY TP 401716
TAPPET ASSY, includes
9 & 17-19 (6)

SHIM (as required) **34**

PART #	THICKNESS INCH/MM
SR400047	.004/0.102
SR400048	.006/0.152
SR400049	.008/0.203
SR400050	.012/0.304
SR400051	.016/0.406
SR400052	.032/0.812
SR400053	.048/1.206
SR400054	.062/1.587
SR400055	.078/1.981

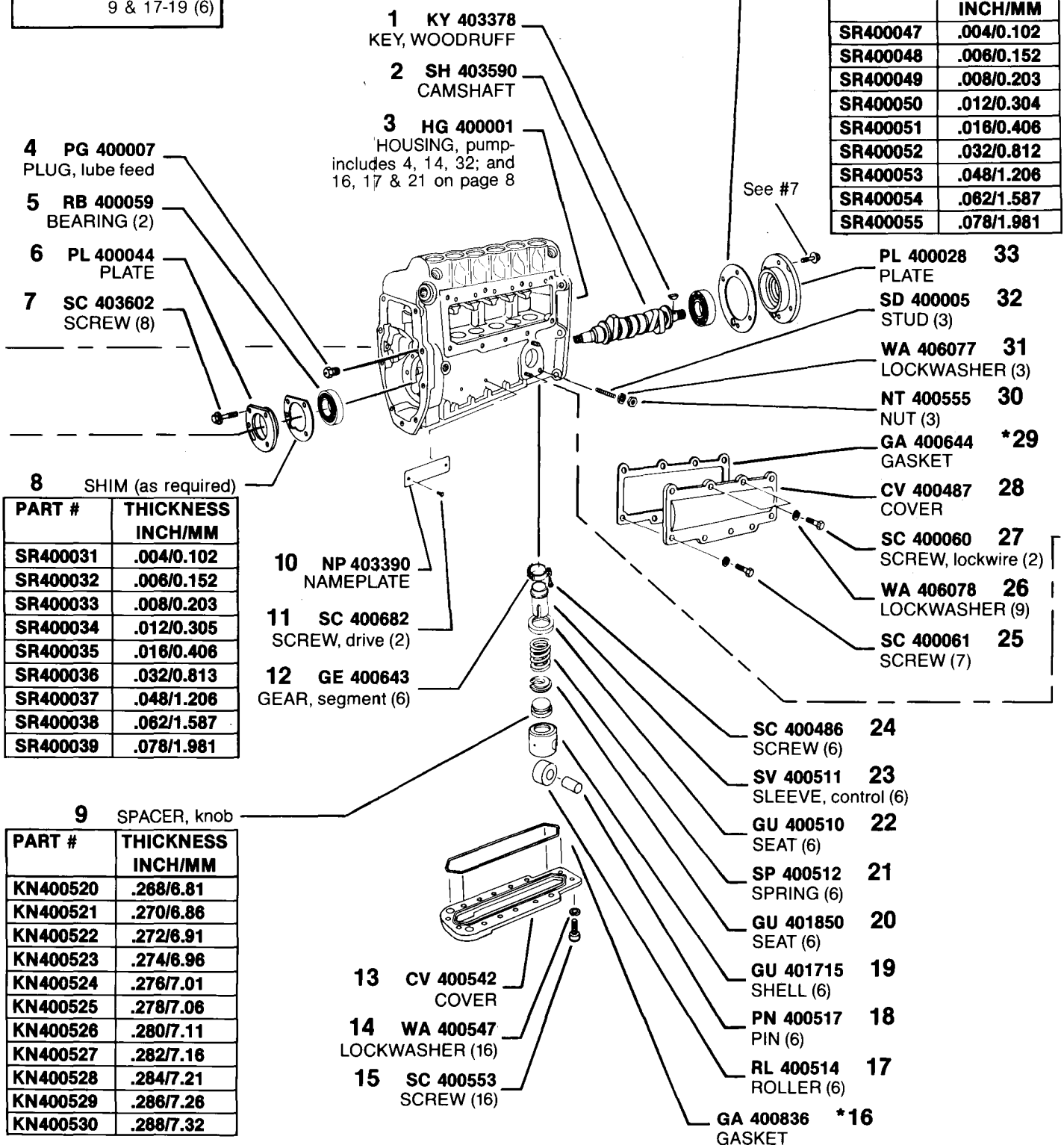

8 SHIM (as required)

PART #	THICKNESS INCH/MM
SR400031	.004/0.102
SR400032	.006/0.152
SR400033	.008/0.203
SR400034	.012/0.305
SR400035	.016/0.406
SR400036	.032/0.813
SR400037	.048/1.206
SR400038	.062/1.587
SR400039	.078/1.981

9 SPACER, knob

PART #	THICKNESS INCH/MM
KN400520	.268/6.81
KN400521	.270/6.86
KN400522	.272/6.91
KN400523	.274/6.96
KN400524	.276/7.01
KN400525	.278/7.06
KN400526	.280/7.11
KN400527	.282/7.16
KN400528	.284/7.21
KN400529	.286/7.26
KN400530	.288/7.32

*Denotes parts in Gasket Kit, KT 401705.

MODEL 300 #PLM 450213

ASSY VA 400683
OVERFLOW VALVE
 ASSY-includes 22
 thru 25

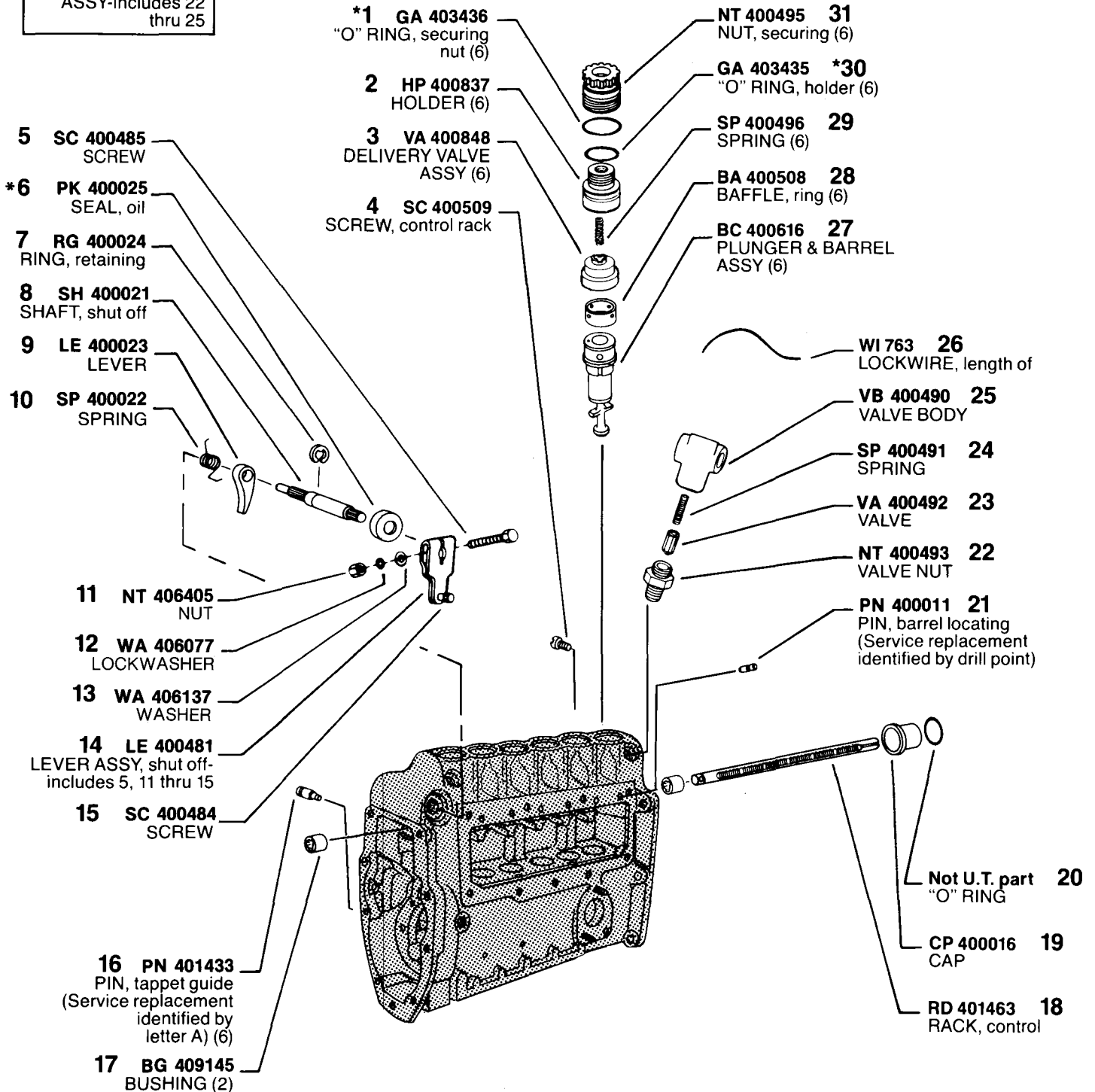

*Denotes parts in Gasket Kit KT 401705.

MODEL 300 #PLM 450213

ASSY SPT 400710
SUPPLY PUMP ASSY

1 HG 400758
HOUSING ASSY,
includes 8 & 12

2 PN 400605
PIN

3 SP 400708
SPRING

4 GU 400602
TAPPET

5 RL 400603
ROLLER

***6 GA 400554**
GASKET

7 PN 400604
PIN

8 SPINDLE

PLUNGER ASSY 12

PART #	THICKNESS MM	COLOR CODE
PC400561	24.984/24.989	Two white dots
PC400562	24.986/24.991	Two green dots
PC400563	24.988/24.993	Two yellow dots
PC400564	24.990/24.995	Two red dots
PC400565	24.992/24.997	Two blue dots
PC400566	25.083/25.087	Three black dots
PC400567	25.085/25.089	Two black dots
PC400568	25.089/25.093	Two red & two black dots

PART #	THICKNESS MM	COLOR CODE
SL400581	4.993/4.995	Red one end
SL400582	4.995/4.997	Blue one end
SL400583	4.997/4.999	Yellow one end
SL400743	5.020/5.022	Yellow one end White one end
SL400744	5.044/5.046	Yellow one end Black one end
SL400745	5.067/5.069	White one end Black one end
SL400584	5.087/5.089	White one end
SL400585	5.089/5.091	Black one end
SL400586	5.091/5.093	Green one end
SL400587	5.093/5.095	Alum. one end
SL400746	5.116/5.118	Alum. one end Red one end
SL400747	5.139/5.141	Alum. one end Blue one end
SL400748	5.162/5.164	Alum. one end Yellow one end
SL400589	5.189/5.191	Red both ends
SL400590	5.191/5.193	Blue both ends
SL400591	5.193/5.195	Yellow both ends
SL400592	5.195/5.197	Black both ends

SPINDLE (requires reaming)

PART #	THICKNESS MM	COLOR CODE
SL7912-1	5.557/5.560	Red & blue one end
SL7912-2	5.561/5.564	Red & green one end
SL7912-3	5.565/5.568	Red & yellow one end
SL7912-4	5.569/5.572	Blue & green one end

SC 400753 11
SCREW

GA 400610 10
GASKET

SP 400709 9
SPRING

*Denotes parts in Gasket Kit KT 401705.

MODEL 300 #PLM 450213

ASSY MP 404760
MANUAL PRIMER
ASSY-includes 6
thru 12

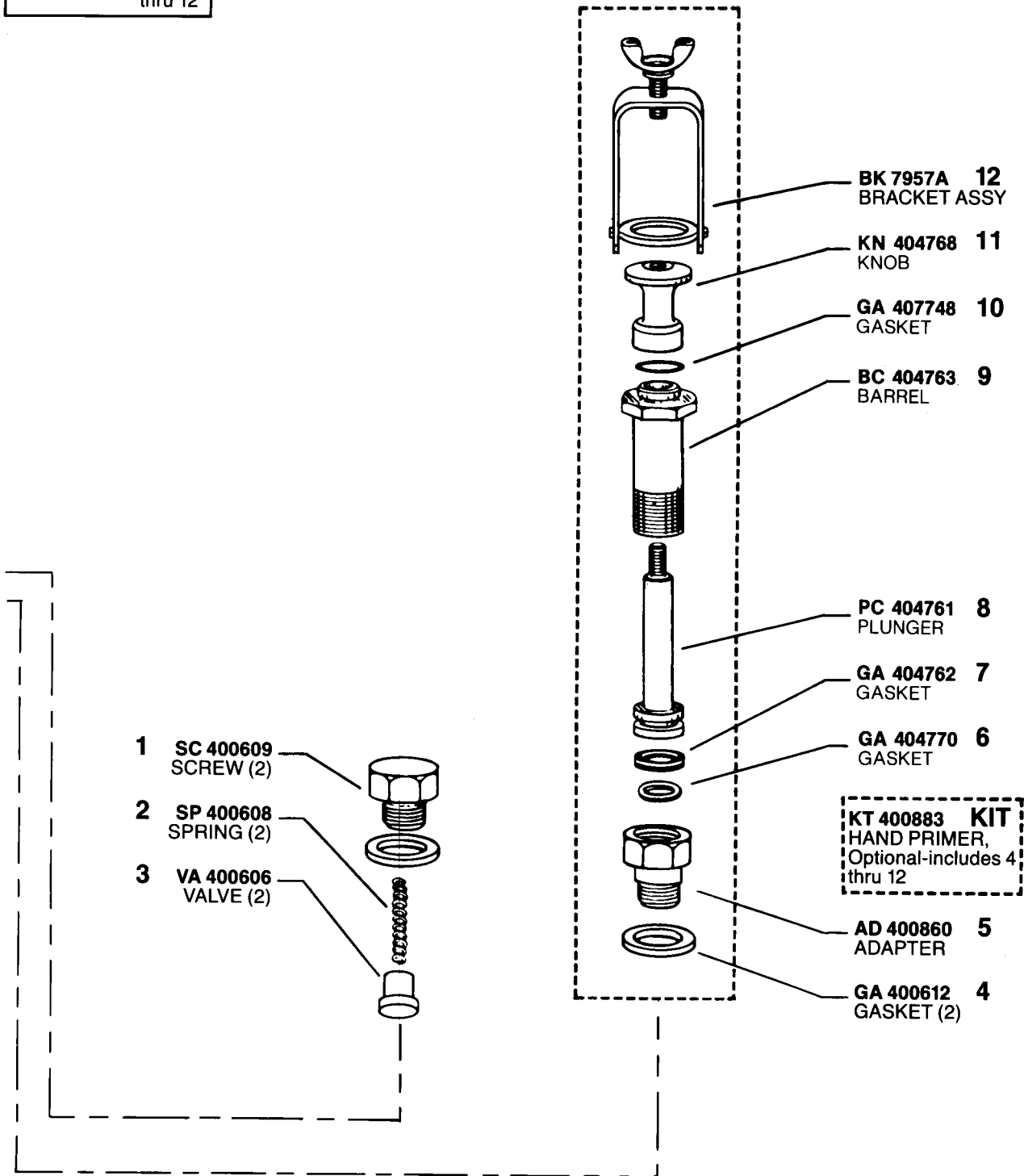

MODEL 300 #PLM 450213

