

# TOOL CATALOG

Supersedes Sections D 2200/1, Issued May, 1977 & D 2200/4, Issued October, 1978

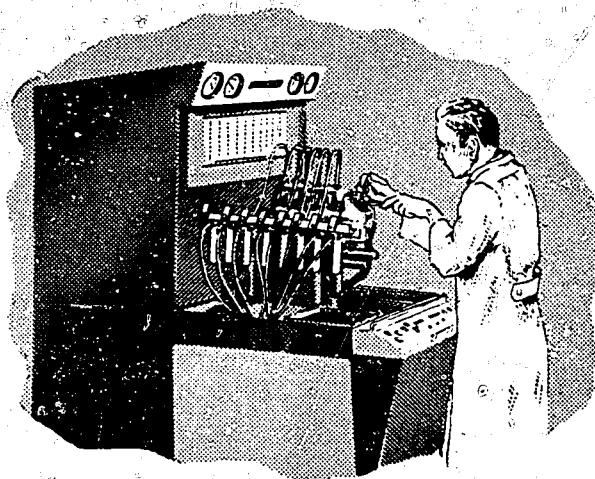

# FUEL INJECTION SYSTEM SERVICE TOOL CATALOGUE

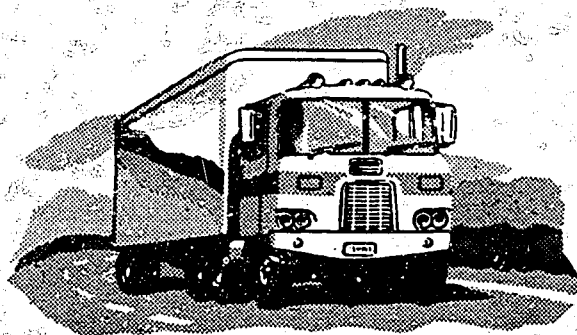

THIS CATALOGUE LISTS ALL CURRENTLY ACTIVE SERVICE TOOLS

## IMPORTANT:

A TOOL NUMBER WITH A SUFFIX LETTER IS A MODIFIED VERSION OF THE ORIGINAL TOOL (EXAMPLE: TSE 76199B IS A MODIFIED TSE 76199). IN MOST CASES, BOTH TOOLS PERFORM THE SAME FUNCTIONS.

## INDEX

	PAGE		PAGE
Notes . . . . .	2	PSU Tools . . . . .	7
Miscellaneous Tools . . . . .	3	PUB Tools . . . . .	7
Model 100 Tools . . . . .	3	GVA/GVB Tools . . . . .	7
APE Tools . . . . .	4	Hydraulic-Head Tools . . . . .	8
APF Tools . . . . .	5	Hand Primer & Supply Pump Tools . . . . .	8
PLB Tools . . . . .	5	Nozzle & Nozzle Holder Tools . . . . .	8
PSB Tools . . . . .	5	Illustrations . . . . .	9
PSJ & PSM Tools . . . . .	6		

## NOTES

1. LU 3003-6 is supplied by the Electrical Products Division, P.O. Box 2228, McCrary Road, Columbus, Mississippi 39701.
2. TSE 4500 and TSE 7664D are no longer supplied by American Bosch. Contact \*Bacharach for a suitable equivalent. Service parts for TSE 4500 and TSE 7664D that are available are supplied by \*Bacharach.
3. TSE 7722D is no longer supplied by American Bosch. \*Bacharach #65-0030 with #65-0275 is a suitable equivalent. Service parts for TSE 7722D that are available are supplied by \*Bacharach.
4. TSE 7733 is no longer supplied by American Bosch. \*Bacharach #66-0554 is a suitable equivalent.
5. TSE 7762 is no longer supplied by American Bosch. A Handylite #222 (Welch Allyn Inc., Auburn, N.Y.), or equivalent, is a suitable replacement and can be obtained at any medical supply house. Light bulb TSE 7762-1 is available for use with TSE 7762.
6. No longer supplied by American Bosch. However, details will be provided upon request so that the tool can be fabricated locally.
7. TSE 7971 is no longer supplied by American Bosch. TSE 76233 is a suitable replacement.
8. TSE 77105 is no longer available. TSE 77108 is a suitable replacement when used with the appropriate accessories.
9. TSE 7995-6 is not supplied separately. Use TSE 7995.
10. TSE 8500 is no longer supplied by American Bosch. Service parts for TSE 8500 are available from the Federal Machine & Tool Co., Emmitt & Pine Sts., Bristol, Conn. 06012. Federal Machine Tool #FMT No. 1 is a suitable replacement for TSE 8500.
11. TSE 8810 is no longer supplied by American Bosch. Use #1 internal "Tru Arc" pliers.
12. TSE 76141A is no longer supplied by American Bosch. Use \*Bacharach #67-5598 (Viscor #1487C calibrating oil).
13. TSE 76160D is primarily an APE tappet compressing tool incorporating a bar which is adaptable for use as a head holding tool. A fabricated bar can be made from brass 0.765"-0.775" (19.4-19.7mm) wide by 0.490" - 0.500" (12.4-12.7mm) thick by 6" (15.3cm) long.
14. TSE 76176 is no longer supplied by American Bosch. Use #22, external, "Tru-Arc" pliers.
15. TSE 76189 is no longer supplied by American Bosch. TSE 76199B is a suitable replacement.
16. TSE 76202 is no longer supplied by American Bosch. Use #23 "Tru Arc" pliers.
17. TSE 4500-512 is for 8 cylinder pumps that require ADN 8S 2C nozzles for calibration. This TSE includes:  
8 - ADN 8S 2C                      8 - AKB 50S 3495B  
  
TSE 4500-850 is for 8 cylinder pumps that require  
ADN 12 SD 12C nozzles for calibration. This TSE includes:  
8 - ADN 12 SD 12C                      8 - AKB 50S 3495B  
  
TSE 4600-1000 is for 6 cylinder pumps that require  
ADN 12 SD 12C nozzles for calibration. This TSE includes:  
6 - ADN 12 SD 12C                      6 - AKB 50S 3495B  
  
TSE 4600-2000 is for 6 cylinder pumps that require  
ADN 8S 2C nozzles for calibration. This TSE includes:  
6 - ADN 8S 2C                              6 - AKB 50S 3495B
18. TSE 4500-506 is no longer supplied by American Bosch. \*Bacharach #67-0108 is a suitable equivalent.
19. TSE 7664-80 is no longer supplied by American Bosch. \*Bacharach #67-0741 is a suitable equivalent.
20. TSE 4500-122 is no longer supplied by American Bosch. \*Bacharach #167-7033 is a suitable equivalent.
21. TSE 4500-123 is no longer supplied by American Bosch. \*Bacharach #167-0194 is a suitable equivalent.
22. TSE 7751B is no longer supplied by American Bosch. \*Bacharach #65-7038 with #65-0274 is a suitable equivalent. Service parts for TSE 7751B that are available are supplied by \*Bacharach.
23. TSE 76118 is no longer supplied by American Bosch. Use TSE 76118-1 and an appropriate delivery valve holder and gasket either from stock or from the pump being serviced.  
**IMPORTANT:** TSE 76118 & 76118-1 are applicable to delivery valves that require copper gaskets. (See Note 24)
24. TSE 76197 is no longer supplied by American Bosch. Use TSE 76197-1 and an appropriate delivery valve holder and NT 7664 holder nut either from stock or from the pump being serviced.  
**IMPORTANT:** TSE 76197 & 76197-1 are applicable to delivery valves that require "O" ring gaskets. (See Note 23)
25. TSE 76218 is no longer supplied by American Bosch. TSE 76232 is a suitable replacement.
26. ST 425-1 & ST 425-3 are no longer supplied by American Bosch. Snap-on #CJ 81D, or equivalent is a suitable replacement. (Jaws may require slight grinding for some applications.)
27. Use TSE 76240B with Snap-on puller CJ 81D and 6" jaws CJ 282-1. (Jaws require slight grinding to eliminate any side loading.)
28. TSE 76238 is no longer supplied by American Bosch. TSE 76160D is a suitable replacement.
29. The accessories for TSE 77108, (TSE 77108-5, -6, -7, -8 & -9) must be ordered separately.

\* BACHARACH INSTRUMENT CO., 625 Alpha Drive, RIDC Industrial Park, Pittsburg, Pennsylvania 15238

**MISCELLANEOUS**

TOOL NUMBER	DESCRIPTION	APPROX. WEIGHT	SEE NOTE
BM 10007	Lapping Compound (Fine)	9 oz. (255 gm)	-
LU 3003-6	Grease (High Temperature)	6.5 lbs. (3 kg)	1
TSE 7723	Mutton Tallow	6 oz. (170 gm)	-
TSE 7752	Lapping Compound (Medium)	9 oz. (255 gm)	-
TSE 76121	Gasket Sealer (1 quart - .9 liter)	20 oz. (567 gm)	-
TSE 76141A	Calibrating Oil	-	12
TSE 77103	Lapping Compound (Silicon Carbide - Course) for nitralloy material	7 oz. (198 gm)	-
TSE 77107-4/6 or /8	Calibrating Unit Kit (Includes 6 or 8 - PCU-25D 040 w/ .4 mm orifice plates)	12.3 lbs. (5.7 kg.) or 16.5 lbs. (7.5 kg.)	-
" " -5/6 or /8	Calibrating Unit Kit (Includes 6 or 8 - PCU 25D 050 w/ .5 mm orifice plates)	12.3 lbs. (5.7 kg.) or 16.5 lbs. (7.5 kg.)	-
" " -6/6 or /8	Calibrating Unit Kit (Includes 6 or 8 - PCU 25D 060 w/ .6 mm orifice plates)	12.3 lbs. (5.7 kg.) or 16.5 lbs. (7.5 kg.)	-
" " -7/6 or /8	Calibrating Unit Kit (Includes 6 or 8 - PCU 25D 070 w/ .7 mm orifice plates)	12.3 lbs. (5.7 kg.) or 16.5 lbs. (7.5 kg.)	-
" " -8/6 or /8	Calibrating Unit Kit (Includes 6 or 8 - PCU 25D 080 w/ .8 mm orifice plates)	12.3 lbs. (5.7 kg.) or 16.5 lbs. (7.5 kg.)	-
TSE 77109-4	Orifice Plate - .4 mm	-	-
" " -5	" " - .5 mm	-	-
" " -6	" " - .6 mm	-	-
" " -7	" " - .7 mm	-	-
" " -8	" " - .8 mm	-	-
TSE 77110-5/8	Calibrating Unit Kit (Includes 8 - PCU 25D 6707A1 w/ .5mm orifice plates)	16.5 lbs. (7.5 kg.)	-

**MODEL 100 FUEL INJECTION PUMPS**

TOOL NUMBER	DESCRIPTION	APPROX. WEIGHT	SEE NOTE	SEE FIGURE
ST 425-1	Drive Hub Puller	-	26	1
ST 425-3	Puller Jaws (Set of 2)	-	26	2
TSE 4500-512	Nozzle & Holder Calibrating Kit) For Her-	13.5 lbs. (6.1 kg)	17	-
TSE 4600-2000	Nozzle & Holder Calibrating Kit) cules Pumps	10.5 lbs (4.8 kg)	17	-
TSE 7913D	Coupling Holding Wrench	24 oz. (680 gm)	-	28
TSE 7986	Delivery Valve Seat Lapping Tool (150°)	6 oz. (170 gm)	-	45
TSE 7986-1	Lapping Arbor (Part of TSE 7986)	2 oz. (57 gm)	-	45
TSE 7995	Governor Bushing (BG 8526) Installation Kit (Includes TSE 7995-1, -2, -6 & -8)	2 lbs. (907 gm)	-	50
TSE 7995-1	Governor Bushing (BG 8526) Reamer	12 oz. (340 gm)	-	50
TSE 7995-2	Governor Bushing (BG 8526) Puller	3 oz. (85 gm)	-	50
TSE 7995-6	Governor Bushing (BG 8526) Pressing Tool	-	9	50
TSE 7995-8	Governor Bushing (BG 8526) Epoxy Kit	8 oz. (227 gm)	-	-
TSE 76160D	Head Holding Tool	24 oz. (680 gm)	13	63
TSE 76193D	Pump Mounting Bracket	2 lbs. (907 gm)	-	70
TSE 76199B	Plunger Spring Compressing Tool	5 oz. (142 gm)	-	74
TSE 76203	Camshaft Protection Cap	2 oz. (57 gm)	-	77
TSE 76220B	Governor Spring Adjustment Gauge	22 oz. (624 gm)	-	81
TSE 76226	Delivery Valve Testing Adapter	4 oz. (113 gm)	-	82
TSE 76227	Tappet Clearance Checking Gauge	11 oz. (312 gm)	-	83
TSE 76232	Governor Drive Gear Nut Spanner Wrench	1 oz. (28 gm)	-	84
TSE 76240B	Drive Gear Hub Puller (For British Leyland Pumps)	28 oz. (784 gm)	27	87
TSE 76241	Drive Gear Hub Holding Wrench (For British Leyland Pumps)	30 oz. (840 gm)	-	88
TSE 77107-5/6 or /8	Pump Calibrating Unit Kit (Includes 6 or 8 - PCU 25D 050 w/ .5 mm orifice plates) (For I.H. and British Leyland Pumps)	12.3 lbs. (5.7 kg) or 16.5 lbs. (7.5 kg)	-	-
TSE 79103	Puff Limiter Clamp Calibration Tool	15.0 oz. (425 gm)	-	101

**APE FUEL INJECTION PUMPS** (Also see "GVA/GVB Governor" and "Hand Primers and Supply Pumps")

TOOL NUMBER	DESCRIPTION	APPROX. WEIGHT	APPLICABLE TO	SEE NOTE	SEE FIGURE
ST 425-1	Drive Hub Puller	-	All	26	4
ST 425-3	Hub Puller Jaws (Set of 2)	-	All	26	2
TSE 761	Tappet Lever	6 oz. (170 gm)	All		3
TSE 4500-512	Nozzle & Holder Calibrating Kit	13.5 lbs. (6.1 kg)		17	-
TSE 4500-850	Nozzle & Holder Calibrating Kit	13.5 lbs. (6.1 kg)		17	-
TSE 4600-1000	Nozzle & Holder Calibrating Kit	10.5 lbs. (4.8 kg)		17	-
TSE 4600-2000	Nozzle & Holder Calibrating Kit	10.5 lbs. (4.8 kg)		17	-
TSE 7619-1	Spring Collet	16.5 oz. (468 gm)	B	SEE FIGURE 6	
TSE 7620-1X	Spring Collet	16.5 oz. (468 gm)	BB, Z		
TSE 7621	Outer Bearing Race Puller	20 oz. (567 gm)	BB, 8V	FOR	
TSE 7621-1	Spring Collet	15.5 oz. (468 gm)	BB, 8V		
TSE 7621-6	Spring Collet	16.5 oz. (468 gm)	BB	REFERENCE	
TSE 7621-7	Spring Collet	16.5 oz. (468 gm)	8V		
TSE 7621-8	Spacer	13.5 oz. (384 gm)	8V	INFORMATION	
TSE 7635	Control Rack Bushing Reamer	21 oz. (595 gm)	B, BB, 8V, Z		5
TSE 7661	Mechanical Fingers	4 oz. (113 gm)	All		7
TSE 7664	Calibrating Stand	-	All	2	-
TSE 7675	Closing Plug Wrench	6 oz. (170 gm)	B, Z		8
TSE 7682	Delivery Valve Puller	14 oz. (397 gm)	A, B		9
TSE 7695	Segment Adjusting Pin	1 oz. (28 gm)	All		11
TSE 7697	Tappet Lifter	2 oz. (57 gm)	BB, VBB, Z		12
TSE 7699	Delivery Valve Puller (Excluding Mack & Allis-Chalmers)	14 oz. (397 gm)	BB, Z		13
TSE 7913D	Coupling Holding Wrench	24 oz. (680 gm)	All		28
TSE 7919	Friction Clutch Drive Hub Nut Wrench	10 oz. (283 gm)	All except Mack		30
TSE 7920	Friction Clutch Puller	13 oz. (369 gm)	All		31
TSE 7920-2	Screw	2 oz. (57 gm)	All		31
TSE 7933	Drive Coupling Puller (Excluding Mack)	16 oz. (454 gm)	BB, Z		32
TSE 7947B	Adjustable Friction Clutch Torque Wrench	8 oz. (227 gm)	All		39
TSE 7960	Camshaft Barring Tool (for checking end play)	2 lbs. (907 gm)	All except 8V		42
TSE 7998	Governor Spring Gap Gauge	2 oz. (57 gm)	BB, 8V		51
TSE 76114B	Camshaft Ball & Roller Bearing Inner Race Way Pressing Tool	19 oz. (539 gm)	B, BB, VBB, Z		53
TSE 76118	Delivery Valve Testing Tool	-	BB	23	
TSE 76118-1	Delivery Valve Testing Adapter	8 oz. (227 gm)	BB		54
TSE 76145	Control Rack Bushing Pressing (In) Tool	7 oz. (198 gm)	BB, 8V		57
TSE 76150	Control Rack Bushing Drive Rod	13 oz. (369 gm)	B, BB, Z		58
TSE 76156B	Tappet Retaining Pin	3 oz. (85 gm)	6BB "Q", 8V		60
TSE 76157	Base Plug Wrench	4 oz. (113 gm)	BB "Q"		61
TSE 76159E	Plunger Spring Compressing Tool	4 lbs. (1.8 kg)	BB, 8V		62
TSE 76160D	Tappet Compressing Tool	24 oz. (680 gm)	BB, 8V		63
TSE 76176	"Tru Arc" Pliers	-	8V	14	-
TSE 76196	Delivery Valve Puller for Threaded Valve Bodies (Allis-Chalmers & Mack)	5 oz. (142 gm)	BB, 8V		71
TSE 76197	Delivery Valve Testing Tool	-	BB, 8V	24	-
TSE 76197-1	Delivery Valve Testing Adapter	9 oz. (255 gm)	BB, 8V		72
TSE 76237	Pronged Socket for Overflow Valve	-	8V	6	-
TSE 76238	Tappet Compressing Tool	-	BB, 8V	28	-
TSE 76242	Non-Threaded Delivery Valve				
	(VA 76264A & VA 76272A) Extractor	2 oz. (57 gm)	BB, 8V		89
TSE 76242-1	Delivery Valve Extractor Nylon Body (Included in TSE 76242)	1 oz. (28 gm)	BB, 8V		-
TSE 76243	Camshaft Protection Cap	3 oz. (85 gm)	8V		90
TSE 76246	Idle Gear Shaft Puller	2.7 lbs. (1.2 Kg)	8V		91
TSE 76247	Control Rack Bushing Reamer (spiral)	22 oz. (624 gm)	BB, 8V		92
TSE 76249	Bearing Plate Retaining Screw Socket	2 oz. (57 gm)	BB, 8V		93
TSE 76250	Tachometer Drive Coupling Puller	6 oz. (170 gm)	8V		94
TSE 77107-7/6 or /8	Calibrating Unit Kit (Includes 6 or 8-PCU 25D 070 w/.7mm orifice plates)	12.3 lbs. (5.7 Kg) or 16.5 lbs. (7.5 Kg)	BB (Fiat Only)		-
TSE 79100	"K" Dimension Gauge (for pumps applied to 1975, 1976, etc. Mack ENDT 675, 676, 865 & 866 engines)	9 oz. (255 gm)	BB, 8V		98



## APF FUEL INJECTION PUMPS

TOOL NUMBER	DESCRIPTION	APPROX. WEIGHT	APPLICABLE TO	SEE NOTE	SEE FIGURE
TSE 7682	Delivery Valve Puller	5 oz. (142 gm)	A, B		9
TSE 8410	Nozzle & Holder Assembly for Full Load Calibration (1.25 mm dia. orifice)	2.5 lbs. (1.2 kg)	C, CC, CQ, D		-
TSE 8411	Nozzle & Holder Assembly for Idle Load Calibration (.5 mm dia. orifice)	2.5 lbs. (1.2 kg)	C, CC, CQ, D		-
TSE 76143	Control Rack Bushing Reamer	26 oz. (737 gm)	D, DD		56
TSE 76145	Control Rack Bushing Pressing (Out) Tool	7 oz. (198 gm)	BC, C		57
TSE 76152	Control Rack Bushing Reamer	16 oz. (454 gm)	CC, CG, CQ		59
TSE 76153	Control Rack Bushing Pressing (Out) Tool	10 oz. (283 gm)	CC, CG, CQ		57
TSE 76154	Control Rack Bushing Pressing (In) Tool	14 oz. (397 gm)	CC, CG, CQ		57

## PLB FUEL INJECTION PUMPS

TOOL NUMBER	DESCRIPTION	APPROX. WEIGHT	SEE NOTE	SEE FIGURE
TSE 7682	Delivery Valve Puller	5 oz. (142 gm)		9
TSE 76188	Pump Mounting Plate	-	6	66

## PSB FUEL INJECTION PUMPS

TOOL NUMBER	DESCRIPTION	APPROX. WEIGHT	WITH INTERNAL OR EXTERNAL SPRING GOVERNOR	SEE NOTE	SEE FIGURE
ST 425-1	Drive Hub Puller	-		26	1
ST 425-3	Hub Puller Jaws (Set of 2)	-		26	2
TSE 4500	Calibrating Stand	-		2	-
TSE 4500-512	Nozzle & Holder Calibrating Kit	13.5 lbs. (6.1 kg)		17	-
TSE 4500-850	Nozzle & Holder Calibrating Kit	13.5 lbs. (6.1 kg)		17	-
TSE 4600-1000	Nozzle & Holder Calibrating Kit	10.5 lbs. (4.8 kg)		17	-
TSE 4600-2000	Nozzle & Holder Calibrating Kit	10.5 lbs. (4.8 kg)		17	-
TSE 7664D	Calibrating Stand	-		2	-
TSE 7682	Delivery Valve Puller	5 oz. (142 gm)			9
TSE 7722D	Nozzle Tester (For pressurizing pump)	-		3	14
TSE 7919	Friction Clutch Drive Hub Nut Wrench	10 oz. (283 gm)			30
TSE 7935	Weight Bushing Pressing (In) Tool	4 oz. (113 gm)	Inter. Spring		33
TSE 7937	Weight Bushing Pressing (Out) Tool	4 oz. (113 gm)	Inter. Spring		33
TSE 7938	Ball Bearing Pressing (In) Tool	7 oz. (198 gm)	Exter. Spring		35
TSE 7950	Camshaft Locking Device	14 oz. (397 gm)			41
TSE 7971	Sleeve Assy (SV 901A & SV 7910A) Ball Bearing Pressing Tool	-		7	43
TSE 76175	Camshaft Bushing Pressing Tool	20 oz. (567 gm)			64
TSE 76176	"Tru Arc" Pliers	-		14	-
TSE 76179B	Camshaft & Ball Bearing Pressing Tool	9 oz. (255 gm)			65

## Section D 2200/1

TOOL NUMBER	DESCRIPTION	APPROX. WEIGHT	WITH INTERNAL OR EXTERNAL SPRING GOVERNOR	SEE NOTE	SEE FIGURE
TSE 76189	Plunger Spring Compressing Tool	-		15	74
TSE 76190	Spring Gap Gauge	2 oz. (57 gm)	Inter. Spring		67
TSE 76191	Weight Bushing Reamer	10 oz. (283 gm)	Inter. Spring		68
TSE 76193D	Pump Mounting Bracket	2 lbs. (907 gm)			70
TSE 76198	Delivery Valve Testing Adapter	5 oz. (142 gm)			73
TSE 76199B	Plunger Spring Compressing Tool, Internal Spring Governor Spider Pressing Tool & Tool for Removing Camshaft	5 oz. (142 gm)	Inter. Spring		74
TSE 76200	Tension Bridge for Compressing Outer Plunger Spring	6 oz. (170 gm)			75
TSE 76201	Torque Lever	10 oz. (283 gm)			76
TSE 76202	"Tru Arc" Pliers	-		16	-
TSE 76203	Camshaft Protection Cap	2 oz. (57 gm)			77
TSE 76204	Weight & Spider Pressing Tool	10 oz. (283 gm)	Exter. Spring		78
TSE 76205	Spanner Wrench (Camshaft Ball-Bearing Lock Nut)	5 oz. (142 gm)			79
TSE 76233	Sleeve Ball Bearing Disassembly & Assembly Tool	17 oz. (482 gm)			85
TSE 76233-4	Sleeve Support Plate (Included in TSE 76233)	10 oz. (283 gm)			85

## PSJ &amp; PSM FUEL INJECTION PUMPS

TOOL NUMBER	DESCRIPTION	APPROX. WEIGHT	APPLICABLE TO	SEE NOTE	SEE FIGURE
ST 425-1	Drive Hub Puller	-	All	26	1
ST 425-3	Puller Jaws (Set of 2)	-	All	26	2
TSE 4500-506	Calibrating Stand Drive Coupling	-	All	18	-
TSE 7722D	Nozzle Tester (for pressurizing pump)	-	All	3	14
TSE 7913D	Coupling Holding Wrench	24 oz. (680 gm)	All		28
TSE 7986	Delivery Valve Seat Lapping Tool (150°)	6 oz. (170 gm)	All		45
TSE 7986-1	Lapping Arbor (Part of TSE 7986)	2 oz. (57 gm)	All		45
TSE 7995	Governor Bushing (BG 8526) Installation Kit (includes TSE 7995-1, -2, -6 & -8)	2 lbs. (907 gm)	All		50
TSE 7995-1	Governor Bushing (BG 8526) Reamer	12 oz. (340 gm)	All		50
TSE 7995-2	Governor Bushing (BG 8526) Puller	3 oz. (85 gm)	All		50
TSE 7995-6	Governor Bushing (BG 8526) Pressing Tool	-	All	9	50
TSE 7995-8	Governor Bushing (BG 8526) Epoxy Kit	8 oz. (227 gm)	All		-
TSE 8810	"Tru Arc" Pliers	-	All	11	-
TSE 76175	Camshaft Bushing Pressing Tool	20 oz. (567 gm)	All		64
TSE 76176	"Tru Arc" Pliers	-	All	14	-
TSE 76193D	Pump Mounting Bracket	2 lbs. (907 gm)	All		70
TSE 76202	"Tru Arc" Pliers	-	G. M. C.	16	-
TSE 76203	Camshaft Protection Cap	2 oz. (57 gm)	All		77
TSE 76215	Plunger Spring Compressing Tool	10 oz. (283 gm)	All		80
TSE 76218	Gov. Drive Gear Nut Spanner Wrench	-	All	25	-
TSE 76220B	Gov. Spring Gap Gauge	22 oz. (624 gm)	All		81
TSE 76226	Delivery Valve Testing Adapter	4 oz. (113 gm)	All		82
TSE 76227	Tappet Clearance Gauge	11 oz. (312 gm)	All		83
TSE 76232	Gov. Drive Gear Nut Spanner Wrench	1 oz. (28 gm)	All		84

**PSU FUEL INJECTION PUMPS**

TOOL NUMBER	DESCRIPTION	APPROX. WEIGHT	SEE NOTE	SEE FIGURE
TSE 7986	Delivery Valve Seat Lapping Tool (150°)	6 oz. (170 gm)		45
TSE 7986-1	Lapping Arbor (Part of TSE 7986)	2 oz. (57 gm)		45
TSE 4500-122	Calibrating Stand Drive Fixture	-	20	-
TSE 4500-123	Calibrating Stand Discharge Tubing	-	21	-
TSE 7722D	Nozzle Tester (For pressurizing pump)	-	3	14
TSE 76215	Plunger Spring Compressing Tool	10 oz. (283 gm)		80
TSE 76226	Delivery Valve Testing Adapter	4 oz. (113 gm)		82

**PUB FUEL INJECTION PUMP**

TOOL NUMBER	DESCRIPTION	APPROX. WEIGHT	SEE NOTE	SEE FIGURE
TSE 7682	Delivery Valve Puller	5 oz. (142 gm)		9

**GVA/GVB GOVERNORS**

TOOL NUMBER	DESCRIPTION	APPROX. WEIGHT	APPLICABLE TO	SEE NOTE	SEE FIGURE
TSE 7913D	Coupling Holding Wrench	24 oz. (680 gm)	All		28
TSE 7919	Friction Clutch Drive Hub Nut Wrench (Excluding Mack)	10 oz. (283 gm)	A, B, BK, C, PK		30
TSE 7920	Friction Clutch Puller (Includes TSE 7920-2)	13 oz. (369 gm)	All		31
TSE 7920-2	Puller Bolt (Part of TSE 7920)	3 oz. (85 gm)	All		31
TSE 7935	Weight Bushing Pressing (In) Tool	4 oz. (113 gm)	C, D, PK		33
TSE 7936	Operating Shaft Bushing & Oil Seal Pressing (Out) Tool	3 oz. (85 gm)	C, D, PK		34
TSE 7937	Weight Bushing Pressing (Out) Tool	4 oz. (113 gm)	C, D, PK		33
TSE 7938	Oil Seal Pressing (In) Tool	7 oz. (198 gm)	All		35
TSE 7947B	Adjustable Friction Clutch Torque Wrench	8 oz. (227 gm)	All		39
TSE 7948	Weight Needle Bearing Pressing (In) Tool	-	C, D, PK	6	40
TSE 7971	Sleeve Assembly (SV 901A & SV 7910A) Ball Bearing Pressing Tool	-		7	43
TSE 7987	Operating Shaft Bushing (BG 7947) Pressing (In) Tool	4 oz. (113 gm)	All		46
TSE 7992	Manifold Piston Installation Tool	1 oz. (28 gm)	GVB/D		47
TSE 7993	Retard Start Piston Installation Tool	3 oz. (85 gm)	GVB/D		48
TSE 7994	Manifold Piston Ring Installation Tool	4 oz. (113 gm)	GVB/D		49
TSE 7997	Retard Start Piston Ring Installation Tool	5 oz. (142 gm)	GVB/D		49
TSE 7998	Spring Gap Gauge	2 oz. (57 gm)	GVB/C & D		51
TSE 7999	Retard Start Piston Bore Reamer	9 oz. (255 gm)	GVB/D		52
TSE 76233	Sleeve Ball Bearing Disassembly & Assembly Tool	17 oz. (482 gm)	All		85
TSE 76233-4	Sleeve Support Plate (Included in TSE 76233)	10 oz. (283 gm)	All		85
TSE 79100	"K" Dimension Gauge (For governors applied to 1975, 1976, etc. Mack ENDT 675, 676, 865 & 866 engines)	-	GVB/C, D		98
TSE 79101	Serrated Parallel Fuel Adjustment Wrench	3 oz. (85 gm)	GVB/C, E		99
TSE 79102	Gulmite Screw Socket	1 oz. (28 gm)	GVB/C, E (MACK)		100

**HYDRAULIC HEADS**

TOOL NUMBER	DESCRIPTION	APPROX. WEIGHT	APPLICABLE TO	SEE NOTE	SEE FIGURE
TSE 7682	Delivery Valve Puller	5 oz. (142 gm)	PSB		9
TSE 7986	Delivery Valve Lapping Tool (150°)	6 oz. (170 gm)	Model 100, PSJ, PSM		45
TSE 76160D	Head Holding Tool	24 oz. (680 gm)	Model 100, PSJ, PSM	13	63
TSE 76189	Plunger Spring Compressing Tool	-	PSB	15	74
TSE 76198	Delivery Valve Testing Adapter	5 oz. (142 gm)	PSB		73
TSE 76199B	Plunger Spring Compressing Tool	5 oz. (142 gm)	Model 100, PSB		74
TSE 76215	Plunger Spring Compressing Tool	10 oz. (283 gm)	PSJ, PSM, PSU		80
TSE 76226	Delivery Valve Testing Adapter	4 oz. (113 gm)	Model 100, PSJ, PSM, PSU		82

**HAND PRIMERS & SUPPLY PUMPS**

TOOL NUMBER	DESCRIPTION	APPROX. WEIGHT	APPLICABLE TO	SEE NOTE	SEE FIGURE
TSE 7664-80	Discharge Tubing	-	SPA	19	-
TSE 7722D	Nozzle Tester (For pressurizing supply pump)	-	SPA	3	14
TSE 7914	Valve Seat Refinishing Tool	9 oz. (255 gm)	SPA		29
TSE 7914-3	Emery Discs (For use with TSE 7914) (Pkg. of 100)	1 oz. (28 gm)	SPA		-
TSE 7943	Spindle Bore Reamer	2 oz. (57 gm)	SPA		38
TSE 76176	"Tru Arc" Pliers	-	SGB, SGE	14	-

**NOZZLES & NOZZLE HOLDERS**

TOOL NUMBER	DESCRIPTION	APPROX. WEIGHT	APPLICABLE TO	SEE NOTE	SEE FIGURE
TSE 773	Centering Sleeve	1 oz. (28 gm)	ADL/S, ADN/S		4
TSE 774	Centering Sleeve	1 oz. (28 gm)	ADB/T, ADL/T, ADN/T		4
TSE 775	Centering Sleeve	2 oz. (57 gm)	ADL/U & UM		4
TSE 7722D	Nozzle Tester	-	All Nozzles	3	14
TSE 7724	Needle Holder	1 oz. (28 gm)	All Nozzles		15
TSE 7728	. 25mm Dia. Hole Cleaning Needles (Set of 5)	2 oz. (57 gm)			16
TSE 7729	. 30mm Dia. Hole Cleaning Needles (Set of 5)	2 oz. (57 gm)			16
TSE 7730	. 35mm Dia. Hole Cleaning Needles (Set of 5)	2 oz. (57 gm)			16
TSE 7733	. 15mm Dia. Hole Cleaning Needles (Set of 5)	-		4	16
TSE 7744	Lapping Arbor (90° angle, 7mm Dia. Valve) (Set of 4)	3 oz. (85 gm)	ADL/T		17
TSE 7745	Lapping Arbor (60° angle, 8mm Dia. Valve) (Set of 4)	6 oz. (170 gm)	ADL/T&U, ADN/T		17
TSE 7748	Brass Wire Brush	1 oz. (28 gm)	All Nozzles		18
TSE 7751B	Nozzle Tester	-	All Nozzles	22	19
TSE 7762	Nozzle Inspection Light	-	All Nozzles	5	20
TSE 7769	Lapping Arbor (60° angle, 6mm Dia. Valve) (Set of 4)	3 oz. (85 gm)	ADB/S		21
TSE 7770	Centering Sleeve	1 oz. (28 gm)	ADB/S		22
TSE 7777B	Nozzle Tip Assembly Tool	4 oz. (113 gm)	ADE		23
TSE 7778	Nozzle Tip Plate	8 oz. (227 gm)	ADE		24
TSE 7785	Adapter Ring w/Inlet Stud (Disc.)	-	AKF/U, AKK/T	6	25



NUMBER	DESCRIPTION	WEIGHT	APPLICABLE TO	SEE NOTE	SEE FIGURE
TSE 7795	Nozzle Holding Tool	-	ADE 10S7B & 7C		26
TSE 7797	Lapping Arbor (90°angle-Special EMD) (Set of 4) 5mm Dia.	2 oz. (57 gm)	ADB 150SP-120-6		27
TSE 8500	Valve Refinisher	-	All Nozzles	10	-
TSE 8501	Grinding Wheel (Used w/TSE 8500)	1 oz. (28 gm)	All Nozzles		-
TSE 77105	Nozzle Assembly & Disassembly Tool	-	M, SM Holders	8	95
" " -10	Insert (.376" gap)	2 oz. (57 gm)	M, SM Holders		95
" " -11	Insert (.593" gap)	2 oz. (57 gm)	M, SM Holders		95
" " -12	Spacer	-	M, SM Holders		95
TSE 77106	Lapping Arbor (60°angle, 4.5mm Dia. Valve) (Set of 4)	2 oz. (57 gm)	ADB/M		96
TSE 77108	Nozzle Holder Fixture-includes TSE 77108-3	13 lbs. (5.9 kg)	M & SM Holders	29	97
" " -3	Securing Bolt	5 oz. (142 gm)	M & SM Holders		97
" " -5	Clamping Plate	9 oz. (255 gm)	AKN 83M 6609	29	97
" " -6	Clamping Plate (u/w TSE 77108-9)	9 oz. (255 gm)	AKN 137M 6567 & AKN 137M 6732	29	97
" " -7	Clamping Plate	10 oz. (283 gm)	AKN 90M 6425, AKN 120M 6547 & AKN 110M 6566	29	97
" " -8	Clamping Plate	10 oz. (283 gm)	AKD 98M 6562	29	97
" " -9	Adapter (u/w TSE 77108-6)	4 oz. (113 gm)	AKN 137M 6567 & AKN 137M 6732	29	97

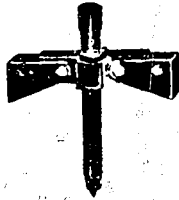

Figure 1 - ST 425-1



Figure 2 - ST 425-3



Figure 3 - TSE 761



Figure 4 - TSE 773, TSE 774 & TSE 775

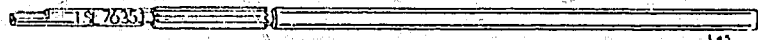

Figure 5 - TSE 7635

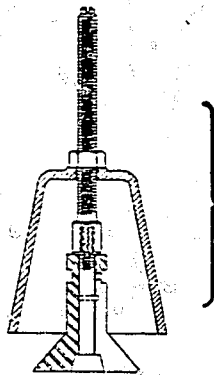
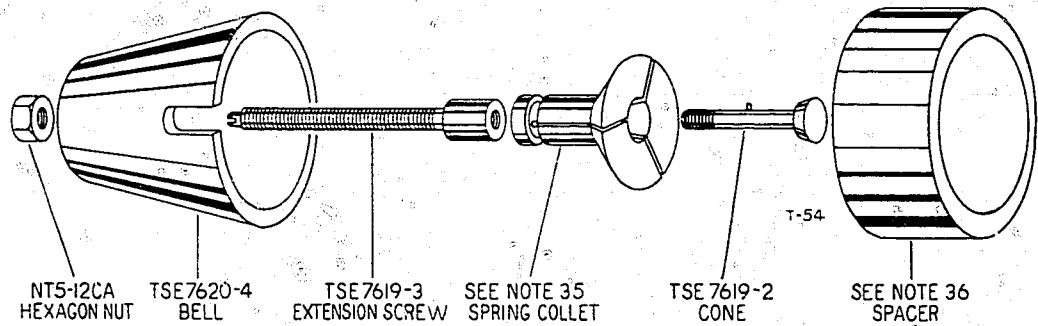

Figure 6 - TSE 7621



NOTE 35. TSE 7621 includes collet TSE 7621-1. Other collets are sold separately. See the following table for recommended usage:

<u>COLLET</u>	<u>PUMP TYPE</u>	<u>BEARING</u>
TSE 7619-1	APE-B	ANY
TSE 7620-1X	APE-BB, Z, 6G, 8VG	NKL 8/25Z, BB 1035, RB 1006
TSE 7621-1	APE-BB, 8VBB	RB 1001
TSE 7621-6	APE-6BB	RB 1004
TSE 7621-7	APE-8VBB	RB 1005

NOTE 36. Spacer TSE 7621-8 is not included in TSE 7621. It has been made available for use with TSE 7620-1X when extracting RB 1006 outer bearing races. See illustration.

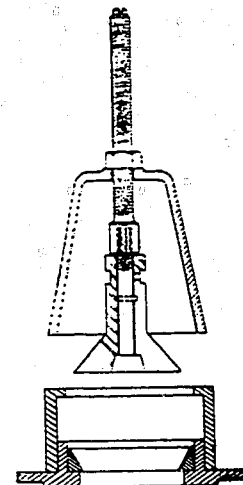

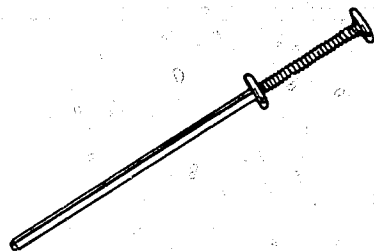

Figure 7 - TSE 7661



Figure 8 - TSE 7675

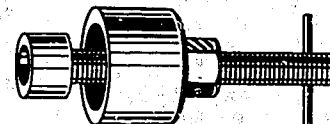

Figure 9 - TSE 7682



Figure 11 - TSE 7695

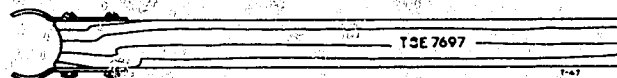

Figure 12 - TSE 7697

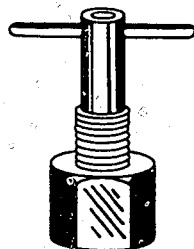

Figure 13 - TSE 7699

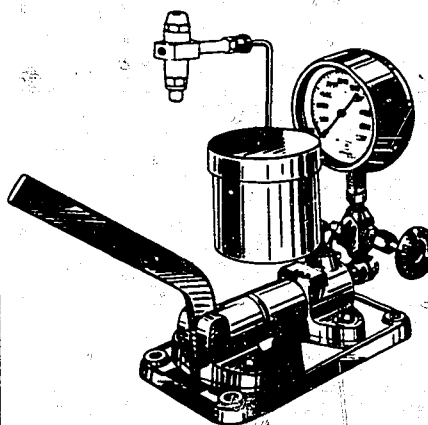

Figure 14 - TSE 7722D

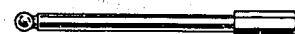

Figure 15 - TSE 7724



Figure 17 - TSE 7744  
TSE 7745

T-9

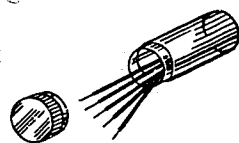

Figure 16 - TSE 7728, TSE 7729,  
TSE 7730, TSE 7733

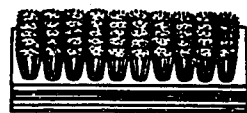

Figure 18 - TSE 7748

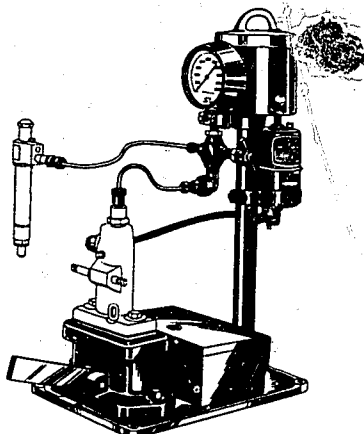

Figure 19 - TSE 7751B



Figure 20 - TSE 7762

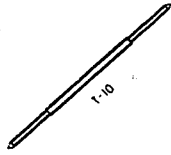

Figure 21 - TSE 7769

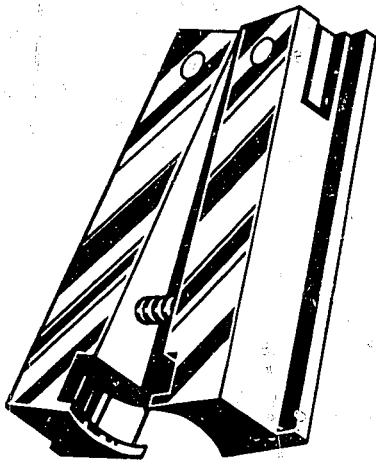

Figure 26 - TSE 7795

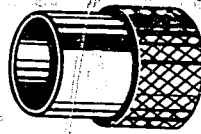

Figure 22 - TSE 7770

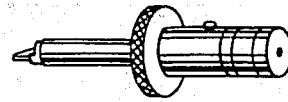

Figure 23 - TSE 7777B

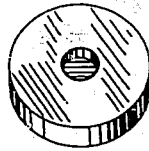

Figure 24 - TSE 7778

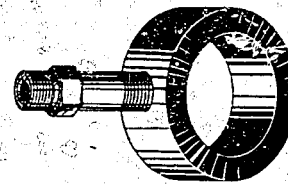

Figure 25 - TSE 7785

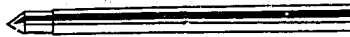

Figure 27 - TSE 7797

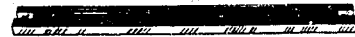

Figure 28 - TSE 7913D

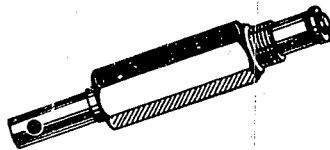

Figure 29 - TSE 7914  
Note: Emery discs (100/pkg)  
available - tool #TSE 7914-3

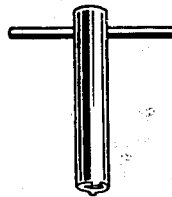

Figure 30 - TSE 7919



Figure 31 - TSE 7920

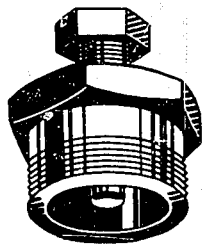

Figure 32 - TSE 7933



Figure 33 - TSE 7935 & 7937



Figure 34 - TSE 7936

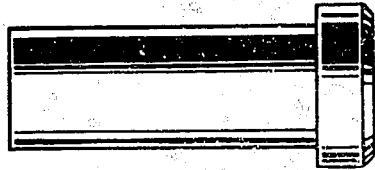

Figure 35 - TSE 7938

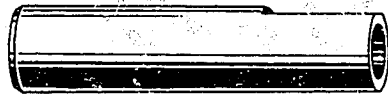

Figure 40 - TSE 7948

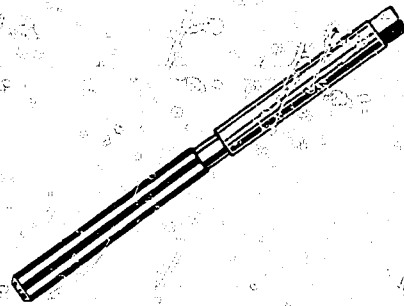

Figure 38 - TSE 7943

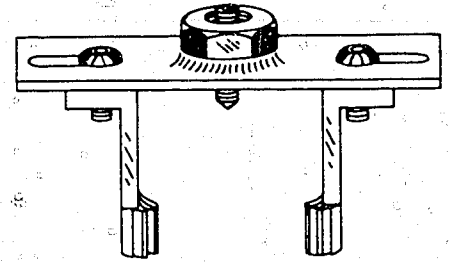

Figure 39 - TSE 7947B

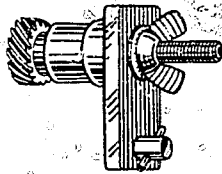

Figure 41 - TSE 7950

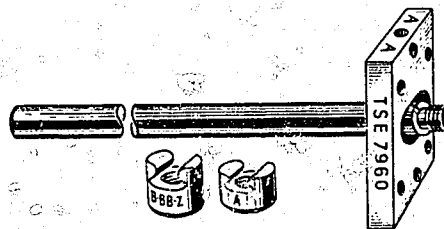

Figure 42 - TSE 7960

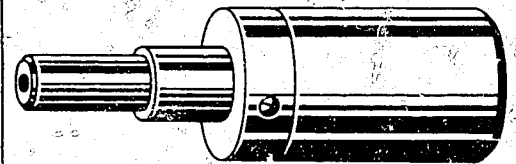

Figure 43 - TSE 7971

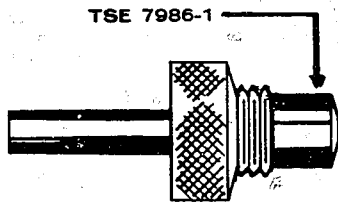

Figure 45 - TSE 7986

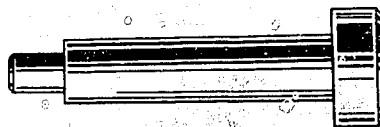

Figure 46 - TSE 7987

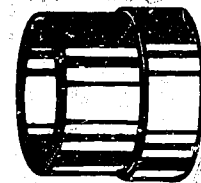

Figure 47 - TSE 7992

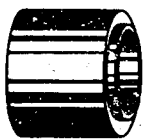

Figure 48 - TSE 7993



Figure 49 - TSE 7994 ("A" = 3/4")  
TSE 7997 ("A" = 1")



TSE - 7995-1

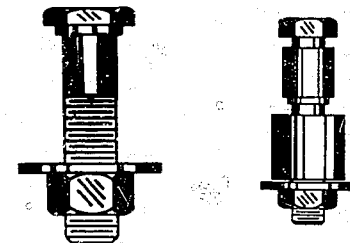

TSE - 7995-2 TSE - 7995-6

Figure 50 - TSE 7995

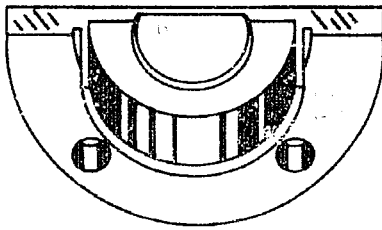

Figure 51 - TSE 7998

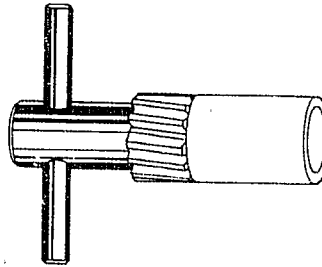

Figure 52 - TSE 7999

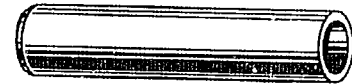

Figure 53 - TSE 76114B



Figure 54 - TSE 76118-1

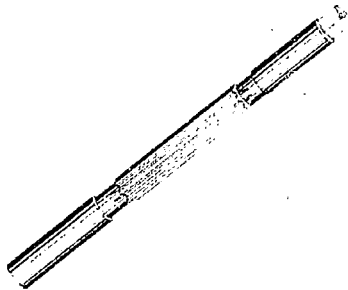

Figure 59 - TSE 76152

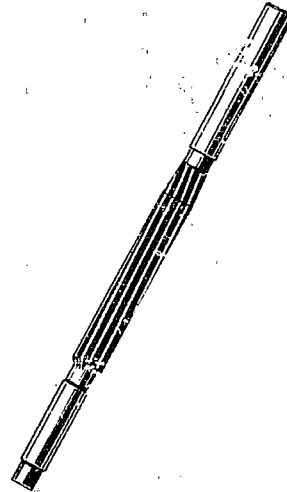

Figure 56 - TSE 76143

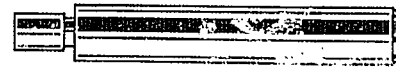

Figure 57 - TSE 76145,  
TSE 76153 & TSE 76154

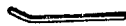

Figure 60 - TSE 76156B

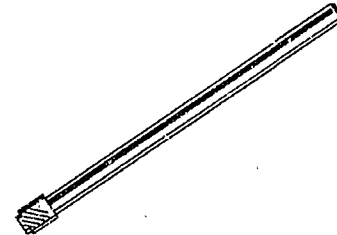

Figure 58 - TSE 76150

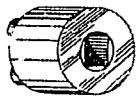

Figure 61 - TSE 76157



Figure 64 - TSE 76175

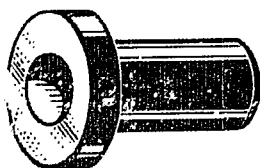

Figure 65 - TSE 76179B

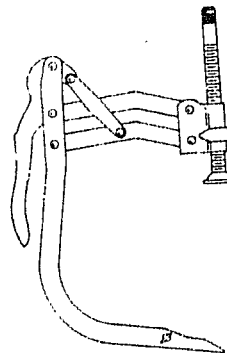

Figure 62 - TSE 76159E

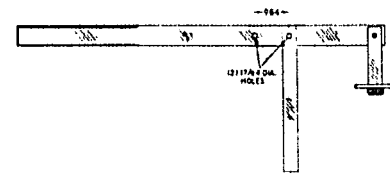

Figure 63 - TSE 76160D

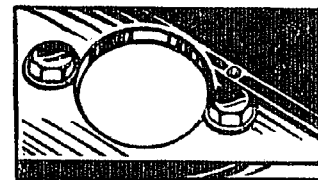

Figure 66 - TSE 76188

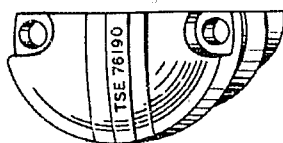

Figure 67 - TSE 76190

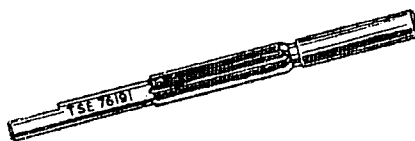

Figure 68 - TSE 76191

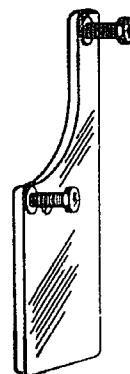

Figure 70 - TSE 76193D

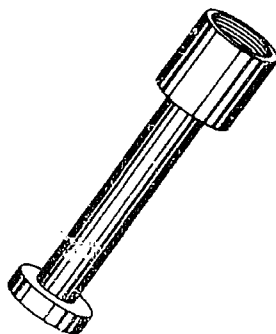

Figure 71 - TSE 76196



Figure 72 - TSE 76197-1



Figure 74 - TSE 76189  
TSE 76199B



Figure 73 - TSE 76198

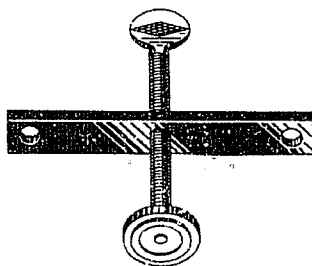

Figure 75 - TSE 76200

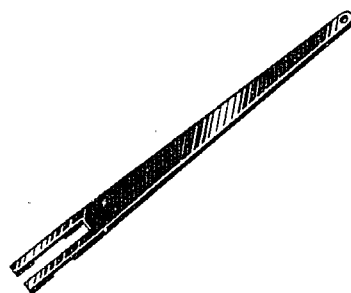

Figure 76 - TSE 76201



Figure 77 - TSE 76203

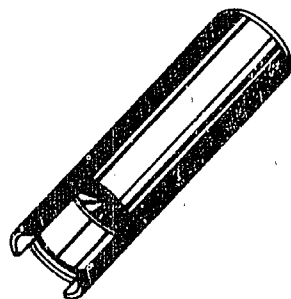

Figure 80 - TSE 76215

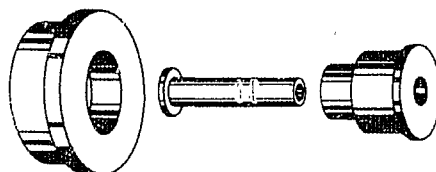

Figure 81 - TSE 76220B

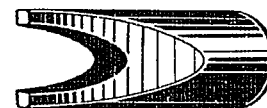

Figure 78 - TSE 76204



Figure 79 - TSE 76205

Section D 2200/1



Figure 82  
TSE 76226

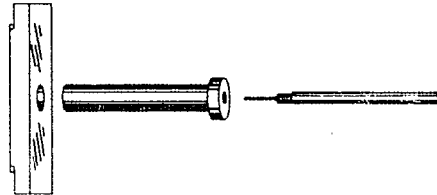

Figure 83 - TSE 76227

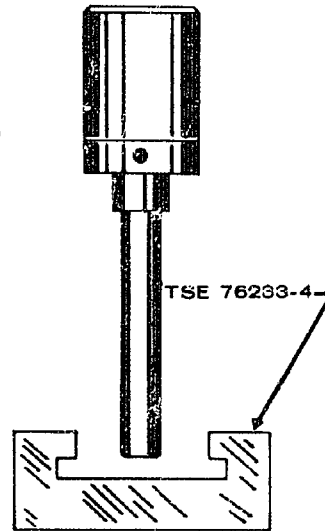

Figure 85 - TSE 76233



Figure 84  
TSE 76232

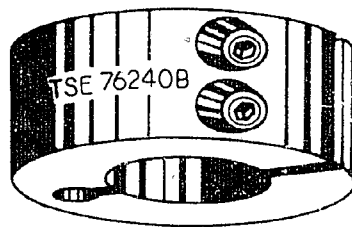

Figure 87 - TSE 76240B

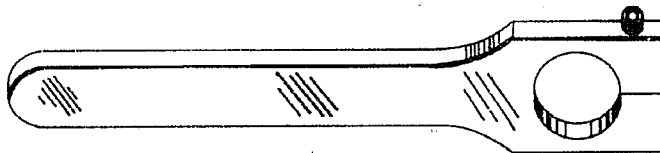

Figure 88 - TSE 76241

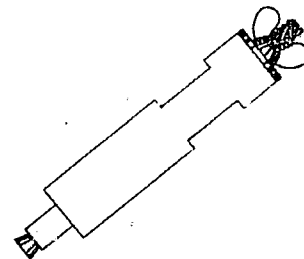

Figure 89 - TSE 76242

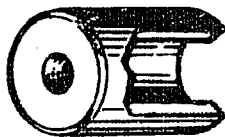

Figure 90  
TSE 76243

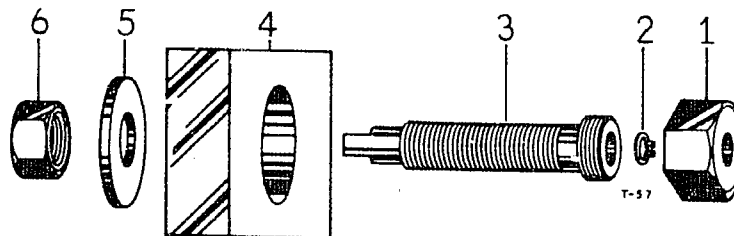
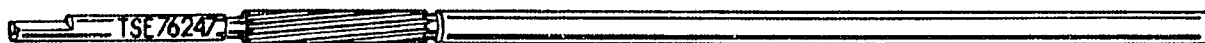

Figure 91 - TSE 76246



T-53

Figure 92 - TSE 76247

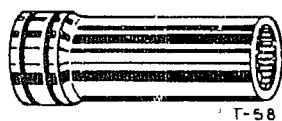

Figure 93 - TSE 76249

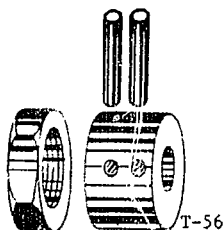

Figure 94 - TSE 76250



Figure 96 - TSE 77106

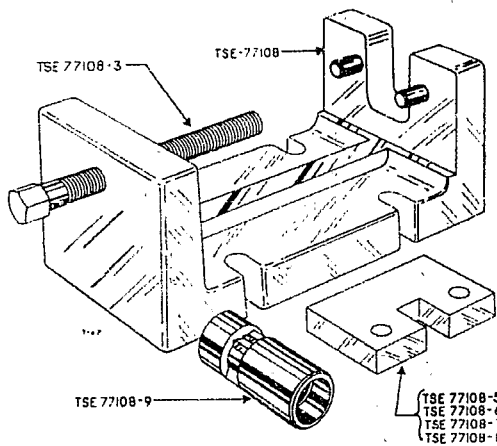

Figure 97 - TSE 77108

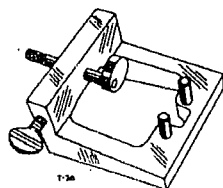

Figure 98 - TSE 79100

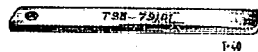

Figure 99 - TSE 79101



Figure 100 - TSE 79102

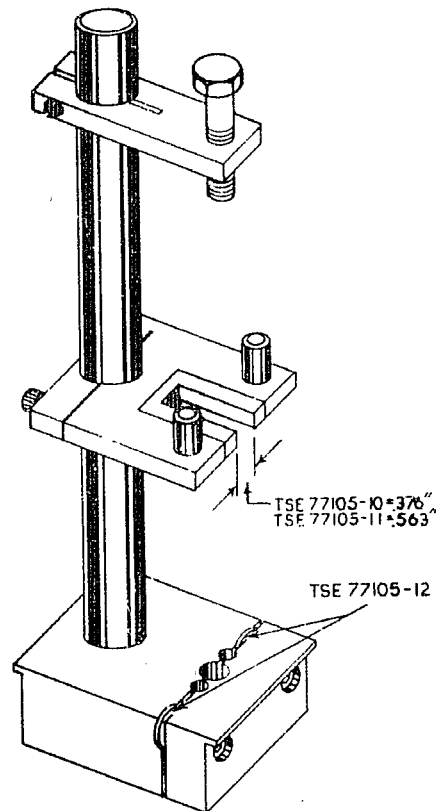

Figure 95 - TSE 77105

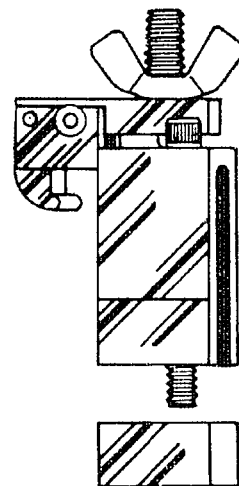

Figure 101 - TSE 79103



## SUPPLEMENT To SERVICE TOOL CATALOGUE

### TSE 76160E - TAPPET COMPRESSING TOOL

Applicable To: APE 6 & 8 Cylinder pumps  
 Used To: Compress tappet spring for installing and removing tappet service pins  
 Weight: 1.5 lbs. (680 gr) List Price: \$41.15 ea.  
 Note: Angled plate (TSE 76160E-7) can be purchased separately and adapted to earlier versions of tool. List Price: \$ 1.45 ea.

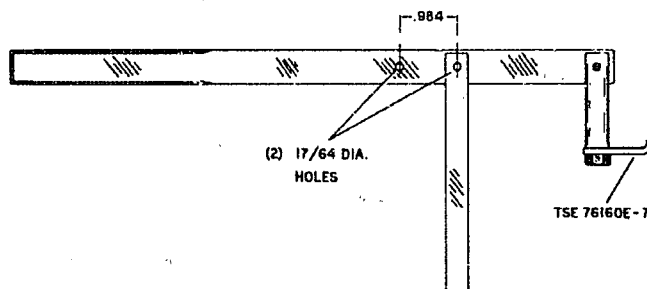

### TSE 76251 - SPACER REMOVER

Applicable To: APE 6G & 8VG pumps  
 Used To: Remove tappet knob spacer (KN 7614-1--)  
 Weight: 0.5 oz. (14 gr) List Price: \$ 6.55 ea.  
 Note: Use with TSE 76255.



### TSE 76252 - DELIVERY VALVE PULLER

Applicable To: APE 6BB, 8VBB, 6G & 8VG pumps  
 Used To: Remove delivery valve bodies (VA 76276-1A) from pump housing  
 Weight: 3.0 oz. (84 gr) List Price: \$13.70 ea.  
 Note: TSE 76252 supersedes TSE 76242. It will allow easier disassembly because of mechanical advantage gained with threaded body and nut. Wider delivery valve bodies prompted release of tool. Tool has been shortened to allow extricating delivery valve while pump is on engine. Nylon body of tool (TSE 76252-5) is available for separate purchase. List Price: \$ 7.20 ea.

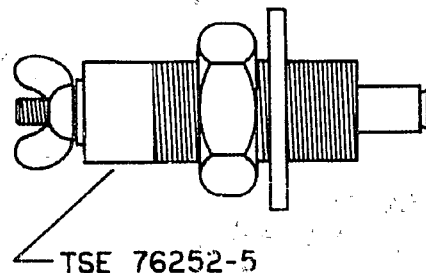

### TSE 76253 - RACE PULLER

Applicable To: APE 6G pumps  
 Used To: Remove inner bearing race from pump camshaft  
 Weight: 3.5 lbs (1.575 kg) List Price: \$45.25 ea.  
 Note: APE 6G pumps incorporate a spacer (SR 7656) behind the bearing inner race which fits in tool and allows more facile disassembly.

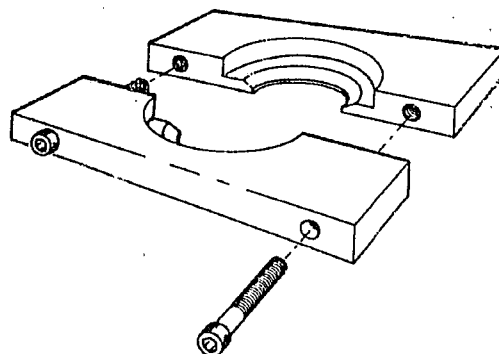

TSE 76254 - LOCATING PIN DIMENSIONING TOOL

Applicable To: APE 6G & 8 VG.  
 Used To: Provide correct assembly dimension when replacing barrel locating pin (PN 7667-1)  
 Weight: 4 oz. (112 gr) List Price: \$10.65

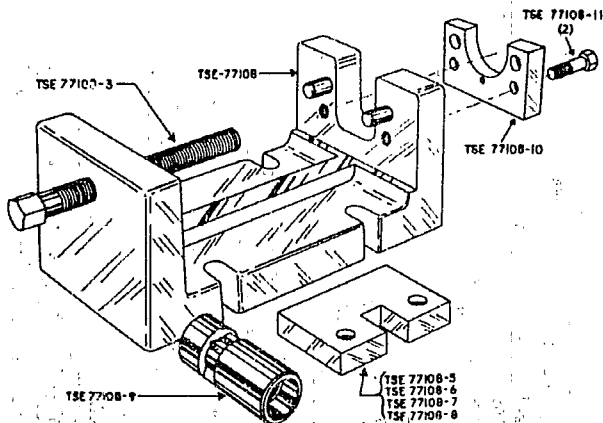
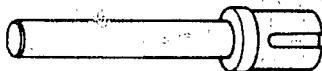

TSE 76255 - PLUNGER SPRING COMPRESSING TOOL

Applicable To: APE 6BB, 8VB, 6G & 8VG  
 Used To: Inactivate tappet spring force to allow replacement of tappet spacers (SR 7610-1-- or (KN 7614-1--))  
 Weight: 1 oz. (28 gr) List Price: \$15.05 ea.

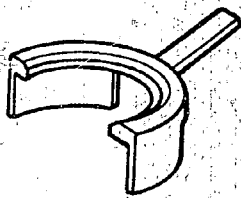

TSE 79104 - GOVERNOR WEIGHT & SHAFT ASSY TOOL

Applicable To: GVB governors  
 Used To: Repair weight and shaft assemblies  
 Weight: 4 lbs. 3oz. (1.88 kg) List Price: \$63.00 ea.

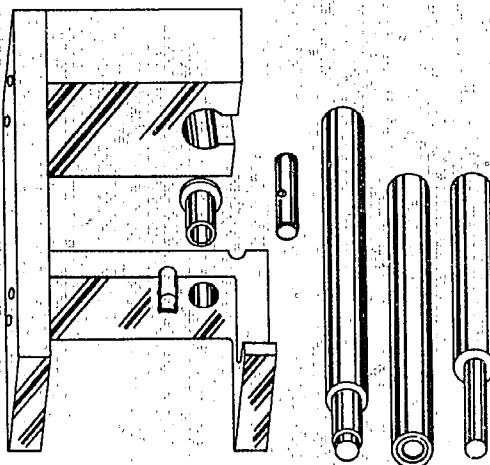

TSE 76257 - DELIVERY VALVE TESTING ADAPTER

Applicable To: APE 6G & 8VG pumps  
 Used To: Test Delivery valves (VA 76276-1A) for seat leakage  
 Weight: 8.5 oz. (238 gr) List Price: \$15.50 ea.  
 Note: Use appropriate holder and securing nut when testing valve.

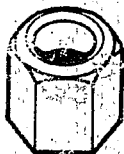

TSE 79105 - RING INSTALLATION TOOL

Applicable To: GVB governors used on APE 6G pumps  
 Used To: Assemble spiral lock ring on GE 79100A governor drive gear  
 Weight: 12 oz. (336 gr) List Price: \$17.70 ea.

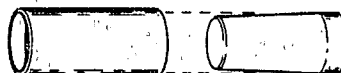

TSE 77108-10 & 11-HOLDER ADAPTER PLATE AND RETAINING SCREWS

Applicable To: AKN 130 SM 6844A  
 Used To: Assemble and disassemble holder and nozzle.  
 Plate-Weight: 9 oz. (252 gr) List Price: \$37.30 ea.  
 Screws-Weight: 0.5 oz. (14 gr) List Price: \$ .80 ea.  
 Note: TSE 77108-10 and -11 are provided separately. Latest base fixtures (TSE 77108) have been modified to accept new parts. Details will be supplied on demand to convert earlier version tools.